

## Step 1 / Client information

### Client

Name
Address
Phone
E-mail

### Deliver to (when different)

Name
Address
Phone
E-mail

### Project

Name
Date
Requested date of delivery (week)

With signoff of this Order form the Client declares, that the Client has read and accepts the General Terms and Conditions of Soltec d.o.o, which are published on [www.soltec.si](http://www.soltec.si).

### Stamp & signature









--

## Step 2 / Product information

### Type of pergola

- Agava SL 160/28
- Agava SL 170/28
- Agava SL 170/36
- Agava SL 240/36
- Agava SL 240/60

### Type of installation

- |   |   |
|---|---|
|  <input type="checkbox"/> Type 1 |  <input type="checkbox"/> Type 5 |
|  <input type="checkbox"/> Type 2 |  <input type="checkbox"/> Type 6 |
|  <input type="checkbox"/> Type 3 |  <input type="checkbox"/> Type 7 |
|  <input type="checkbox"/> Type 4 |  <input type="checkbox"/> Type 8 |

### Dimensions (specify in mm)

--

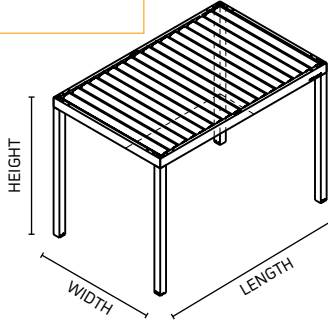

--	--

### Quantity of Pergola

Number
--------

### Number of poles

- 0 poles
- 1 pole
- 2 poles
- 3 poles
- 4 poles
- additional pole: 

--

### Height of pergola

P1
P2
P3
P4

Height of pergola 3-3.5 m is possible only with external foot mounting.  
Extra cost of higher poles and external foot mounting is 160 €.

### Colour

#### Standard STRUCTURE

- |  |   |  |  |
|--|---|--|--|
|  grey anthracite RAL 7016 |  grey aluminium RAL 9006 |  white traffic RAL 9016 |  DB 703 micro-structure |
|--|---|--|--|

#### BLADES

- |  |   |  |   |
|--|---|--|---|
|  grey anthracite RAL 7016 |  grey aluminium RAL 9006 |  white traffic RAL 9016 |  DB 703 smooth |
|--|---|--|---|

### Non-standard

Subject to additional payment.

#### STRUCTURE

RAL no.
Finish

#### BLADES

RAL no.
Finish

## Step 3 / Drawing with marked specifications

Mark motor position, water exit and power supply on top view

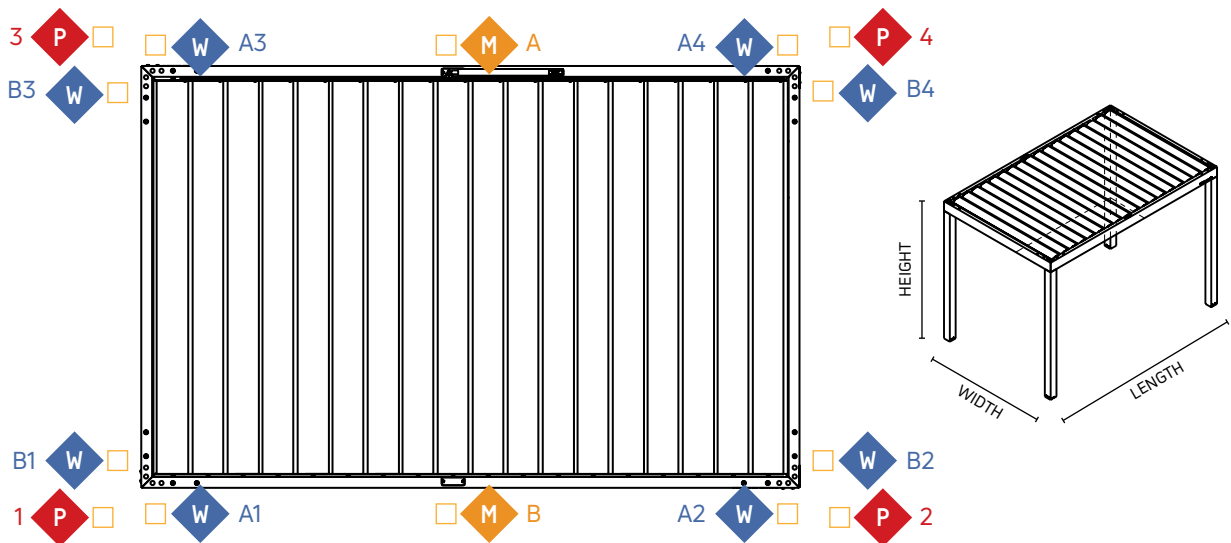

**M** location of motor position

**P** location of power supply

**W** location of water exit

- Water exit is possible on same pole as electricity, but only if Type P is ordered as special option of water evacuation.
- Pergola must have min. 2 water exits!
- Position of cutting is on pole foot.

### Blades opening way

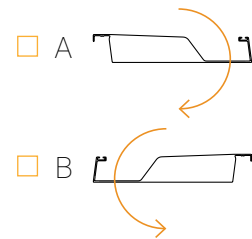

### LED lights

#### A) LED lights integrated into the blades

- LED quantity
- RGB
  - 0,5 m lenght
  - Neutral white 3200 - 5000°K
  - 1 m lenght
  - Warm white 2200 - 3200°K
  - 1,5 m lenght
  - Cold white >5000°K

#### B) LED strip lights

- Length of LED (m)
- RGB

Position of LED lights (mark on drawing)



## Step 4 / Options

### ZIP blinds

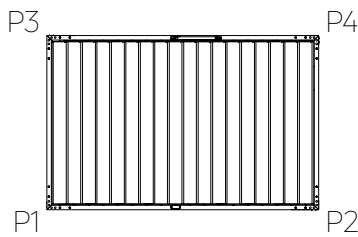

#### Position

- P1 - P2     P1 - P3
- P3 - P4     P2 - P4

#### Fabric Serge

- 108101 grey-white
- 108108 grey
- 108118 grey-black
- 116101 linen-white
- 117101 pearl-white
- 117117 pearl

#### Fabric Soltis

**+ 10%**

#### Crystal full screen

**+ 10%**

#### Crystal window

dim.

#### Motor

- standard
- Somfy

#### Colour of guides

- Same as pergola frame
- Different RAL no.

### Sliding panels

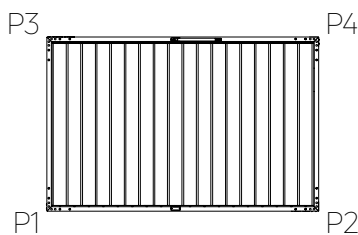

#### Position

- P1 - P2     P1 - P3
- P3 - P4     P2 - P4

#### Sliding type

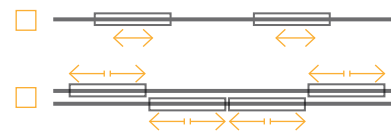

#### Type

- wood
- alu
- screen

#### Number of panels

#### Dimension of panels (width in mm)

#### Colour / Standard

- grey anthracite RAL 7016
- grey aluminium RAL 9006
- white traffic RAL 9016

#### Colour / Non-Standard

Subject to additional payment +10%.

RAL no.

### Glass panels

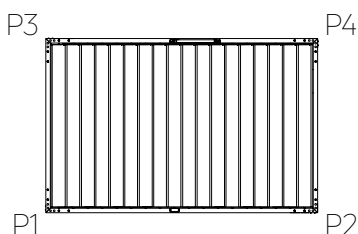

#### Position

- P1 - P2     P1 - P3
- P3 - P4     P2 - P4

#### Folding type



#### Number of panels

#### Dimension of panels (width in mm)

#### Colour / Standard

- grey anthracite RAL 7016
- grey aluminium RAL 9006
- white traffic RAL 9016

#### Colour / Non-Standard

Subject to additional payment +10%.

RAL no.

## Step 5 / Accessories

### Sensors

- Rain sensor
- Wind sensor
- Snow sensor (Rain + Temperature sensor)
- Temperature sensor
- Presence sensor

### Sound system

- Number of speakers
- Audio system
  - Audio system + Bluetooth

### Remote control

- Quantity
- Teleco / 42-channels
  - Somfy / 4-channels
  - Somfy / 1-channel
  - T-mate APP
  - Daisy APP



### Heater Heliosa

- Quantity
- White
  - Anthracite

### Wall mounting

- standard
- optional
  - P1  P3
  - P2  P4

### Foot mounting

- standard (inox) / internal
  - optional / external
-     

### External foot mounting protection

- galvanization
- galvanization + painting
- inox

### Position of holes on profile for wall fixation

- drill the profile (indicate on drawing)
- no drilling (client ensures power supply)

## Step 6 / Options roof

### Covers for non standard length

Subject to additional payment 30 € / m'

- Type A / Convex type
- Type B / Concave type

### Fix roof integration

- Type C / Glass roof
- Type D / Aluminium sheet
- Type E / Aluminium sheet

### Special water evacuation

Subject to additional payment 150 € / pcs

- Type V  Type P
- Type H

## Step 7 / Hand drawing with marked specifications

## Step 8 / Additional comments

### To be filled by Soltec / manufacturer

Value
Shipping
<b>In total</b>
Offer number
Project reference number
Date